

Lighting Control Module Development

Yurii Vizir¹, Olena Chala¹, Svitlana Maksymova¹,
Ahmad Alkhalailah²

¹Department of Computer-Integrated Technologies, Automation and Robotics,
Kharkiv National University of Radio Electronics, Ukraine

²Senior Developer Electronic Health Solution, Amman, Jordan

Abstract:

Lighting control is an extremely pressing task in the modern world. On the one hand, poor lighting leads to reduced safety, including injuries and deaths. On the other hand, excessive lighting leads to excess energy waste, which should be avoided. This article describes the development of a lighting control module based on Arduino Mega. The article provides a selection of the necessary equipment, and a block diagram of the proposed device is also created. A 3D model of the device case was developed, and the case was also printed on a 3D printer. The assembly of the developed lighting control module is proposed.

Key words: Lighting control, Illumination control, Lighting module, Intelligent production, Prototype, 3D printing.

Introduction

In the context of modern trends in the development of enterprises, production is becoming more and more intelligent [1]-[9]. Accordingly, more and more diverse monitoring systems are being applied to it, designed to optimize operation [10]-[16]. In such systems, a wide variety of sensors are widely used, depending on the parameters that are planned to be optimized [17]-[23]. It should be noted that one of the key areas is the so-called “green technologies”, that is, the rational use of resources. There are several areas of application of these technologies, but in this work we will pay attention to saving the use of electricity, namely the rational use of lighting in industrial and other premises.

Illumination level control systems are modern software and hardware complexes that are used to monitor work parameters at workplaces in production

facilities. They contribute to the improvement of labor efficiency, in accordance with sanitary and hygienic standards, through digitalization of production.

The production equipment monitoring system provides complete information about the parameters of the premises, necessary for making management decisions, making timely changes in the production process, automating production, synchronizing equipment, analyzing and optimizing product quality. From this it can be concluded that the lighting control module development is an actual and timely applied task.

Related works

Within the framework of research into “green technologies”, that is, the rational use of resources, a huge amount of research is being carried out. Let's look at some of them related to light level control.

Scientists in [24] note that energy-saving-oriented illumination control always causes optical spectra drifting in light-conversion-material-based white light-emitting diodes, which are conventionally used as artificial luminaires in indoor areas. They propose an approach that can be flexibly applied in large-scale based white light-emitting diodes intelligent controlling systems for industrial workshops and office buildings.

In study [25] the influence factors of illuminance distribution uniformity and the energy-saving ability was researched for the indoor illumination control system, which consists of a white light-emitting diodes matrix and a tabletop matrix.

Authors in [26] consider the enormous waste of electric energy in tunnel lighting. To reduce them researchers propose their intelligent control system of road tunnel lighting which can realize the effect of illumination moving with the vehicle.

Paper [27] state-of-the-art dimming techniques for visible light communication illustrates from a multi-dimensional perspective, including the intensity domain, the time domain, the frequency domain, and the spatial domain.

Researchers in [28] describe the hardware architecture of a light-emitting diode illumination environment control module corresponding to the image acquisition module for a chip-back defect inspection system.

A lighting control system based on Arduino for environmental condition monitoring greenhouse was designed in [29]. The aim was environmental condition monitoring at real-time.

Saravanan, G. and co-authors [30] developed an idea to manage the illumination control of electrical systems in the workplace to control the excess heat and light ray reflection. The sensors sense the operations of selected gadgets over a smart phone.

In [31] it is noted that the use of daylighting reduces energy consumption in buildings, which can be achieved by the implementation of the hybrid illumination systems.

The article [32] considers analysis and investigation of lighting automation system in low-traffic long-roads.

Ghosh, A., & et al. in their work [33] propose an IoT-based illumination monitoring system, which enables the users to measure lux values at multipositional indoor space using mobile sensors and store them in a cloud server network.

We see that a huge amount of scientific work is devoted to lighting control. It should be noted the variety of problems solved in this area. Next in our article we will consider our lighting control module

The modules construction

The designed module can include several sensors and executing devices that will be placed in the production room. The specific architecture includes the following devices:

- ESP32 and Arduino Mega are chosen as the central node;
- a single data exchange bus can be used to ensure data exchange between the central node and other microcontrollers. The SPI protocol was chosen to provide communication between the controllers, because it has a high data transfer rate and a convenient interface for connecting many devices.
- LM393 was chosen as the sensor for the software module for automating the industrial premises illumination level:
- a dimmer with the following characteristics was used: operating voltage up to 280 V alternating current 50 Hz (600 V maximum voltage at the peak); recommended power without radiator up to 150 W; recommended power with radiator from 150 W

to 2000 W; maximum power with radiator up to 3000 W; voltage drop across the key is $1\text{ V} \pm 0.1\text{ V}$.

The lighting module with four outputs contains two output contacts - analog (AO) and digital (DO), as well as two contacts for connecting power. For reading the analog signal, a separate output "AO" is provided, from which you can get voltage values from 0 V to 3.3 V or 5 V, depending on the power source used. The digital output (DO) is set to logic "0" or logic "1" depending on the brightness. The sensitivity of the output can be adjusted using a rotary potentiometer. The output current of the digital output can reach more than 15 mA, which greatly simplifies the use of the module and makes it possible to connect it directly to a single-pin or two-pin relay, bypassing the Arduino controller. Figure 1 shows the schematic diagram of the lighting module based on LM393 with 4 contacts.

The control unit receives the output signal of the comparator and takes appropriate actions depending on the illumination state. For example, it can turn on or off the LEDs, adjust the light intensity, or send a signal to the automatic lighting control system.

This schematic diagram of the light control module provides an accurate measurement of the light level and allows to control the light automatically depending on the needs. It can be used in various applications, such as indoor lighting, automatic control via an app or automatically.

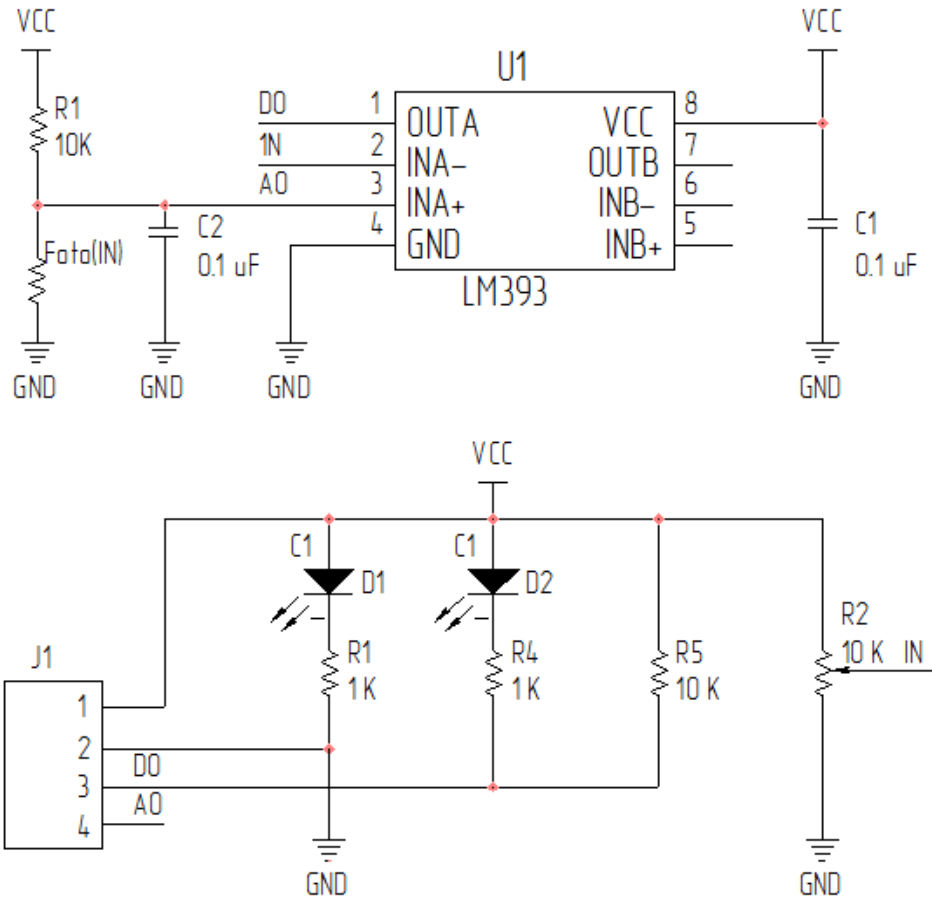
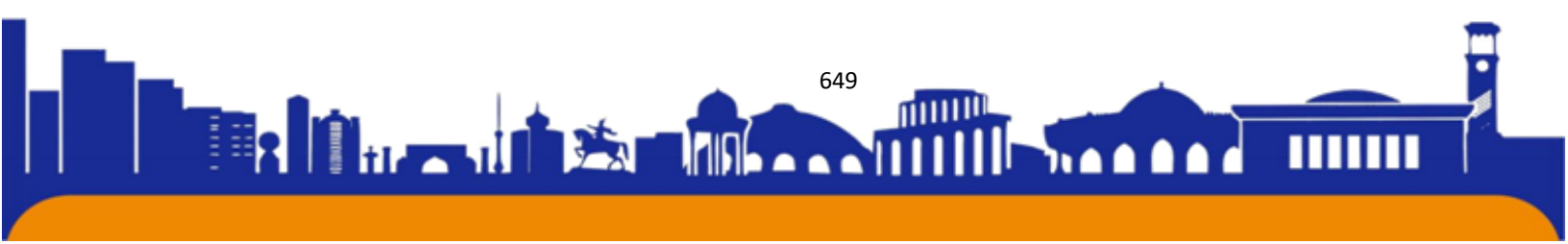

Figure 1: Module schematic diagram

The prototype was assembled based on the developed schemes for the devices. A breadboard was used to create the central node. The appearance of the central node prototype is shown in Figure 2.

This prototype is an intermediate step in the process of developing and validating the lighting control module before its final integration into the system. Its use allows you to check the functionality and efficiency of circuits and components before using them in the final device.



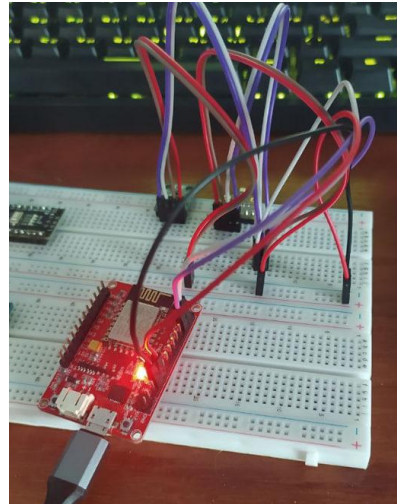

Figure 2: Module central node assembled prototype

For the pre-designed and assembled prototypes, cases were created in which the module components are mounted. To develop a device, it is first advisable to carry out its three-dimensional Modeling [34], [35].

The Blender online service was used for three-dimensional housings modeling. After developing the models, they were measured, and based on this data, a database of three-dimensional models of the cases was created. The case of the central node should have a hole for connecting the microUSB cable to the board. This architectural solution is necessary for charging the internal battery of the device, and also provides a convenient and accessible interface for updating the microcontroller software in case of errors detected during the operation of the module. The process of creating a three-dimensional model of the module central node case using the Blender platform is shown in Figure 3 and Figure 4.

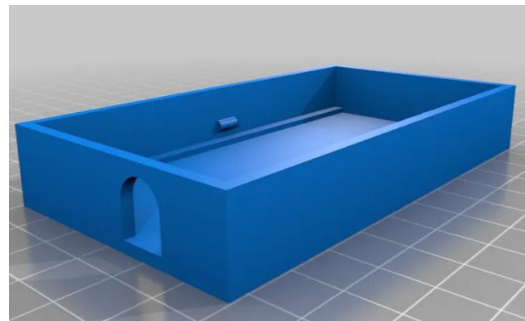

Figure 3: Three-dimensional model of the case, lower part

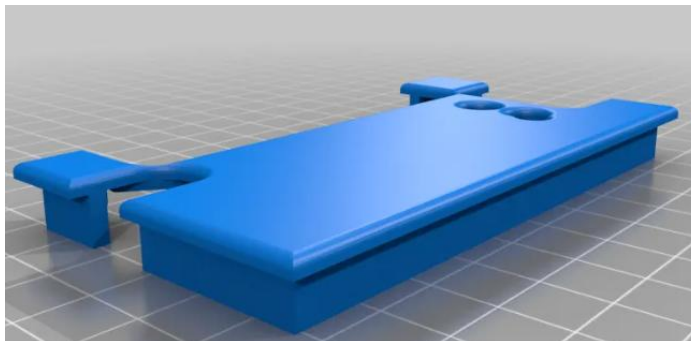

Figure 4: Three-dimensional model of the case, upper part

We decided to make a case using 3D-printing technology, because it is a very accessible and simple way [36], [37]. When choosing 3D printing software, Ultimaker Cura was chosen.

PLA (Polylactic Acid) was chosen as the material for printing the device case, which should ensure that the body is stable, strong and had a smooth surface. PLA is one of the most common materials for 3D printing, and it is made from biodegradable polymers that are resistant to degradation, making it environmentally friendly. It is quite easy to work, does not require special equipment for printing, cools quickly and has high accuracy. In addition, PLA is a sufficiently strong material, which allows you to get a stable and durable body structure. It is also easy to process after printing, such as sanding or painting, to give the final product the desired look.

As a result, I got the plastic case shown in Figure 5 and Figure 6.

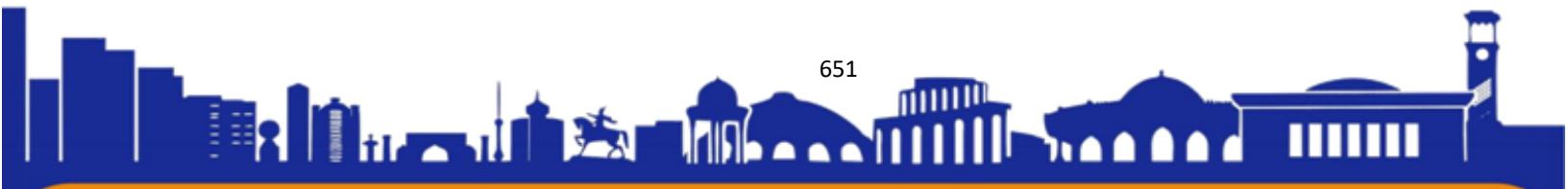



Figure 5: Finished case for the board, bottom view

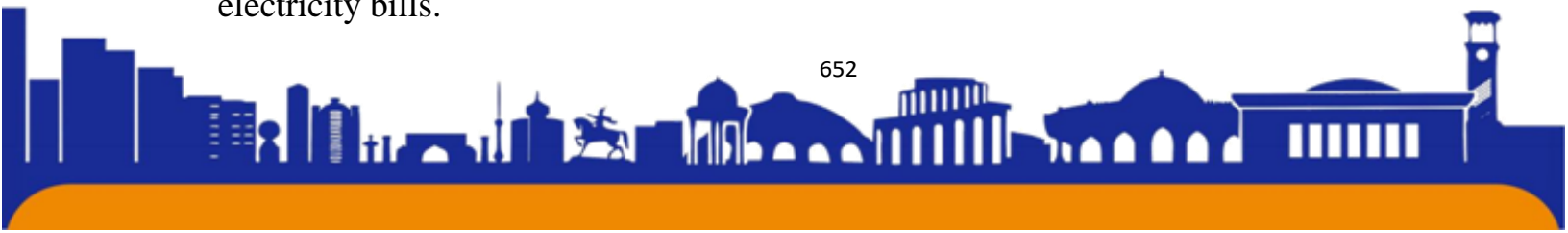

Figure 6: Finished case for the board top view

Conclusion

Lighting control is an important task nowadays for a number of reasons.

Firstly, it is necessary to talk about saving energy. Dimming or automatically turning off lights helps reduce energy consumption, leading to savings on your electricity bills.



Secondly, we note comfort and convenience. The ability to adjust the brightness, color and distribution of light in a room can create a cozy and comfortable atmosphere for work, relaxation or entertainment.

Thirdly, this is a security issue. Smart lighting control, especially using motion sensors, can provide security in your home or outdoors, including occupancy detection and preventing potential incidents.

Fourthly, automation. Automatic lighting control systems can integrate with other smart systems in the home, such as security systems, climate control and audio/video systems, making life more convenient and efficient.

And finally, aesthetics and mood. The ability to adjust the color temperature or lighting of different areas of a room can help create a certain mood or highlight architectural features of the interior.

Lighting control can be a key element to improving efficiency, comfort and safety in workspace or even home.

This paper describes the development of a lighting control module. First, the necessary equipment was selected, then a structural diagram was developed, the product body was created using 3D printing, and the module was assembled.

In the future, it is planned to develop software that will automatically regulate lighting in a production room based on specified parameters.

References:

1. Lyashenko, V., Mustafa, S. K., Sotnik, S., & Ayaz, A. M. (2019). Basic principles of decision making upon receipt of new nanomaterial. *International Journal of Advanced Trends in Computer Science and Engineering*, 8(5), 2680-2685.
2. Mousavi, S.M.H.; MiriNezhad, S.Y.; Lyashenko, V. An evolutionary-based adaptive Neuro-fuzzy expert system as a family counselor before marriage with the aim of divorce rate reduction. In *Proceedings of the 2nd International Conference on Research Knowledge Base in Computer Engineering and IT*, Uttarakhand, India, 24–26 March 2017.
3. Mustafa, S. K., Yevsieiev, V., Nevliudov, I., & Lyashenko, V. (2022). *HMI Development Automation with GUI Elements for Object-Oriented Programming*

Languages Implementation. SSRG International Journal of Engineering Trends and Technology, 70(1), 139-145.

4. Nevliudov, I., Yevsieiev, V., Lyashenko, V., & Ahmad, M. A. (2021). GUI Elements and Windows Form Formalization Parameters and Events Method to Automate the Process of Additive Cyber-Design CPPS Development. *Advances in Dynamical Systems and Applications*, 16(2), 441-455.

5. Sotnik, S., Mustafa, S. K., Ahmad, M. A., Lyashenko, V., & Zeleniy, O. (2020). Some features of route planning as the basis in a mobile robot. *International Journal of Emerging Trends in Engineering Research*, 8(5), 2074-2079.

6. Al-Sharo, Y. M., Abu-Jassar, A. T., Sotnik, S., & Lyashenko, V. (2021). Neural Networks As A Tool For Pattern Recognition of Fasteners. *International Journal of Engineering Trends and Technology*, 69(10), 151-160.

7. Nevliudov, I., & et al.. (2020). Method of Algorithms for Cyber-Physical Production Systems Functioning Synthesis. *International Journal of Emerging Trends in Engineering Research*, 8(10), 7465-7473.

8. Abu-Jassar, A. T., Al-Sharo, Y. M., Lyashenko, V., & Sotnik, S. (2021). Some Features of Classifiers Implementation for Object Recognition in Specialized Computer systems. *TEM Journal: Technology, Education, Management, Informatics*, 10(4), 1645-1654.

9. Baker, J. H., Laariedh, F., Ahmad, M. A., Lyashenko, V., Sotnik, S., & Mustafa, S. K. (2021). Some interesting features of semantic model in Robotic Science. *SSRG International Journal of Engineering Trends and Technology*, 69(7), 38-44.

10. Chen, W. (2020). Intelligent manufacturing production line data monitoring system for industrial internet of things. *Computer communications*, 151, 31-41.

11. Lyashenko, V., & et al. (2023). Automated Monitoring and Visualization System in Production. *Int. Res. J. Multidiscip. Technovation*, 5(6), 09-18.

12. Bondariev, A., & et al. (2023). Automated Monitoring System Development for Equipment Modernization. *Journal of Universal Science Research*, 1(11), 6-16.

13. Abu-Jassar, A. T., Attar, H., Yevsieiev, V., Amer, A., Demska, N., Luhach, A. K., & Lyashenko, V. (2022). Electronic User Authentication Key for Access to HMI/SCADA via Unsecured Internet Networks. *Computational Intelligence and Neuroscience*, 2022, 5866922.

14. Гиренко, А. В., Ляшенко, В. В., Машталир, В. П., & Путятин, Е. П. (1996). Методы корреляционного обнаружения объектов. Харьков: АО "БизнесИнформ, 112.

15. Lyashenko, V., & et al.. (2016). The Methodology of Image Processing in the Study of the Properties of Fiber as a Reinforcing Agent in Polymer Compositions. *International Journal of Advanced Research in Computer Science*, 7(1), 15-18.

16. Khan, A., Joshi, S., Ahmad, M. A., & Lyashenko, V. (2015). Some Effect of Chemical Treatment by Ferric Nitrate Salts on the Structure and Morphology of Coir Fibre Composites. *Advances in Materials Physics and Chemistry*, 5(1), 39-45.

17. Bortnikova, V., & et al. (2019). Mathematical model of equivalent stress value dependence from displacement of RF MEMS membrane. In 2019 IEEE XVth International Conference on the Perspective Technologies and Methods in MEMS Design (MEMSTECH), IEEE, 83-86.

18. Maksymova, S. & Akopov, M. (2023). [Selection of Sensors for Building a 3D Model of the Mobile Robot's Environment](#). In VII International Conference Manufacturing & Mechatronic Systems (2023), 33-35.

19. Nevliudov, I., & et al. (2023). Mobile Robot Navigation System Based on Ultrasonic Sensors. In 2023 IEEE XXVIII International Seminar/Workshop on Direct and Inverse Problems of Electromagnetic and Acoustic Wave Theory (DIPED), IEEE, 1, 247-251.

20. Maksymova, S., Matarneh, R., Lyashenko, V. V., & Belova, N. V. (2017). Voice Control for an Industrial Robot as a Combination of Various Robotic Assembly Process Models. *Journal of Computer and Communications*, 5, 1-15.

21. Matarneh, R., Maksymova, S., Deineko, Z., & Lyashenko, V. (2017). Building robot voice control training methodology using artificial neural net. *International Journal of Civil Engineering and Technology*, 8(10), 523-532.

22. Attar, H., Abu-Jassar, A. T., Amer, A., Lyashenko, V., Yevsieiev, V., & Khosravi, M. R. (2022). Control System Development and Implementation of a CNC Laser Engraver for Environmental Use with Remote Imaging. *Computational intelligence and neuroscience*, 2022, 9140156.
23. Attar, H., Abu-Jassar, A. T., Yevsieiev, V., Nevliudov, I., Lyashenko, V., & Luhach, A. K. (2022). Zoomorphic Mobile Robot Development for Vertical Movement Based on the Geometrical Family Caterpillar. *Computational Intelligence and Neuroscience*, 2022, 3046116.
24. Xiao, H., & et al. (2022). Automatic illumination control method for indoor luminaires based on multichromatic quantum dot light-emitting diodes. *Micromachines*, 13(10), 1767.
25. Xiao, H., & et al. (2023). Influence factors on illuminance distribution uniformity and energy saving of the indoor illumination control method. *Applied Optics*, 62(10), 2531-2540.
26. Wang, Y., & et al. (2020). An “illumination moving with the vehicle” intelligent control system of road tunnel lighting. *Sustainability*, 12(18), 7314.
27. Wang, T., & et al. (2020). Dimming techniques of visible light communications for human-centric illumination networks: State-of-the-art, challenges, and trends. *IEEE Wireless Communications*, 27(4), 88-95.
28. Weng, R. C., & et al. (2019). Design and Implementation of Illumination Control of High Speed Chip-Back Defects Inspection System. In 2019 IEEE 8th Global Conference on Consumer Electronics (GCCE), IEEE, 233-235.
29. Xiao, L., & et al. (2018). Design of Intelligent Illumination Controller for Agricultural Greenhouse Based on Arduino Board. In 2018 7th International Conference on Advanced Materials and Computer Science (ICAMCS 2018), 308-312.
30. Saravanan, G., & et al. (2021). IoT materials enabled indoor light illumination monitoring system. *Materials Today: Proceedings*, 45, 6277-6281.
31. Osma-Pinto, G., & Amado-Duarte, L. (2021). Selection of the control alternative with the minimum energy consumption for the hybrid illumination system of inner spaces. *Journal of Building Engineering*, 35, 102046.
32. Mahmoud, M. M., & Muradkhanli, L. (2020). Safer design and less cost operation for low-traffic long-road illumination using control system based on pattern recognition technique. *Intelligent Control and Automation*, 11(03), 47.

33. Ghosh, A., & et al. (2020). Design and real-time implementation of cloud based indoor illumination monitoring system. *Journal of The Institution of Engineers (India): Series B*, 101, 223-227.
34. Maksymova, S., & et al. (2023). 3D Robot Model Development. *Technical Science Research In Uzbekistan*, 1(4), 255-267.
35. De Melo, M. S. P., & et al. (2019). Analysis and comparison of robotics 3d simulators. In *2019 21st Symposium on Virtual and Augmented Reality (SVR)*, IEEE, 242-251.
36. Nevliudov I., & et al. (2023) A Small-Sized Robot Prototype Development Using 3D Printing. In *XXXI International Conference CAD In Machinery Design Implementation and Educational Issues*, 12.
37. Zhang, J., & et al. (2019). A review of the current progress and application of 3D printed concrete. *Composites Part A: Applied Science and Manufacturing*, 125, 105533.